



StarHub IPTV Box

USER GUIDE

SAMSUNG GX-SH435EH

Contents

Getting Started -----	03
StarHub IPTV Box	03
StarHub Remote Control	04
Guide To High Definition TV Applications -----	05
HDTV	05
Video Resolution	06
Surround Sound	07
Guide to IPTV Features -----	08
Main Menu and Options	08
Info Bar	09
Info Page	10
On-Screen TV Guide	11
Genre Search	12
More Show Times	13
Programme Information In Chinese	14
Favourite Channels	15
Last Channel Recall	16
Search	17
General Settings	18
Parental Control	20
Guide to Video On Demand -----	22
Catalogue Page	22
Info Page	24
My Purchased Content	25
KaraOK! - Song Catalogue	26
KaraOK! - Playlist	27
KaraOK! - Favourites	28
KaraOK! - Other Features	29
Guide To Interactive Services -----	30
Instant Buy	30
Catch Up TV (Available only for Selected Channels)	31
Start Over and eTV	32
Interactive TV	33

Technical Information ----- **34**
 Installation Guide 34
 Recommended Set-Up: Connection via HDMI (High Definition Multimedia Interface) 34
 Optional Set-Up: Connection via Composite Video & Audio 35

Troubleshooting----- **36**
 Tips For Improving TV Reception 36

General Information ----- **37**

Getting Started

STARHUB IPTV BOX

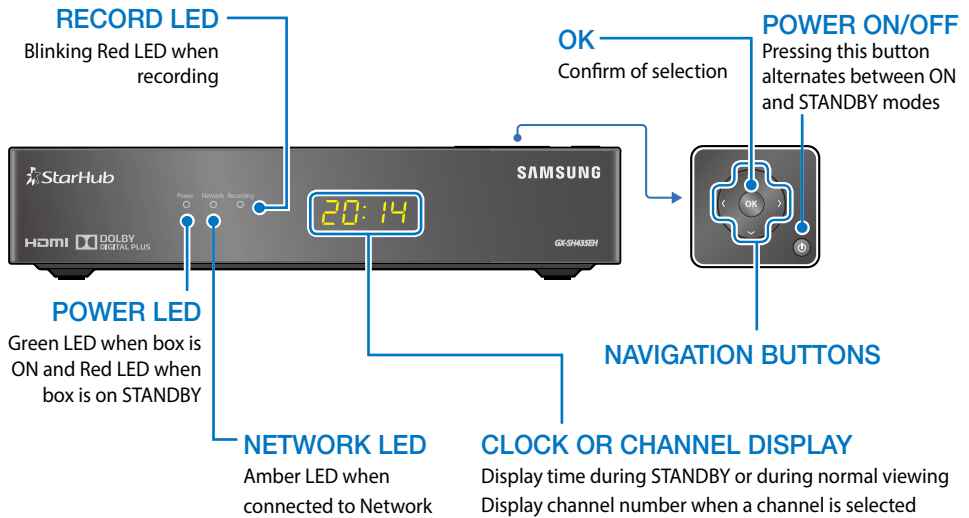

IMPORTANT

- When you switch off your TV set, you should always put the set-top box on stand-by mode for regular software updates.
- Always place your set-top box on a smooth, flat surface.
- Air should circulate freely under and around the box to prevent overheating. Do not place anything on top of your set-top box.
- Do not place the set-top box near wet or moist areas.
- If the Power LED is not Green or Network LED is not solid Amber, power OFF and ON the set-top box to reconnect.
- Do not dismantle the set-top box to attempt servicing it on your own.
- Please provide the error code shown on screen when calling 1633 for technical assistance.

STARHUB REMOTE CONTROL

The StarHub remote control offers you the convenience of accessing the features available from the set-top box remotely.

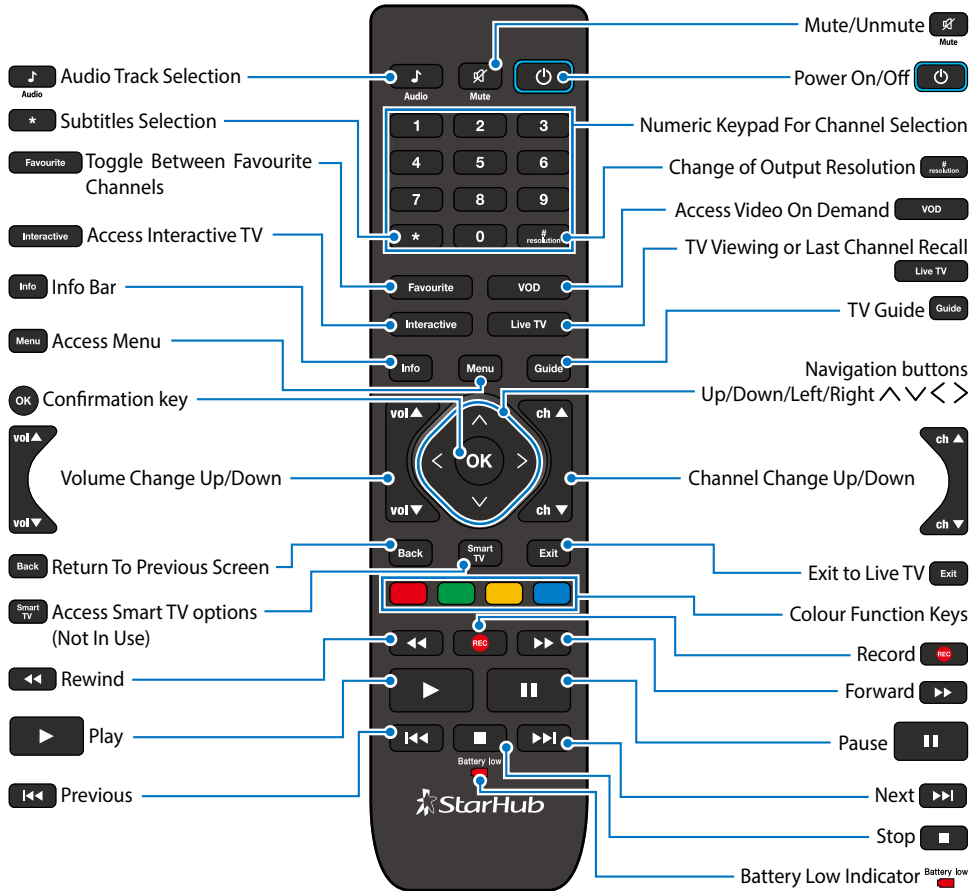

USEFUL REMINDERS

- When using the remote control, make sure there are no obstructions between the remote control and the set-top box.
- If the channels can be changed with the set-top box and not with the remote control, check if the remote control batteries are weak.
- If you cannot change channels using either the set-top box or the remote control, do not attempt your own servicing. Please call 1633.

Guide To High Definition TV Applications

HDTV

With HDTV service on StarHub TV, you and your family will embark on a new level of television viewing experience as never before. In addition to crystal-clear images that are 4 times sharper than standard TV and colours that are true to life, you will enjoy HD programmes in widescreen format just like at the cinema. Dolby Digital 5.1 Surround Sound (where available) capability means that you can enjoy multi-dimensional, cinema-quality sound right in your living room.

What's more, your IPTV set-top box supports both standard definition (SD) and HD channels. Hence, you can conveniently access and view both SD and HD programmes using the same box.

[Here's how to enhance your TV viewing experience.](#)

[Widescreen Picture \(16:9\)](#)

Get a panoramic view of the action with 33% more of the picture to see.

[True-to-life-colours](#)

Be mesmerized by lifelike images with a display of million more colours.

[Crystal Clear Images](#)

You won't miss a single detail with 4x more sharpness than ever before.

[Cinematic Sound](#)

Enjoy Dolby® Digital 5.1 surround sound on selected shows with a compatible speaker system.

[Quality HD Programmes](#)

With the suite of HD channels available on StarHub TV, you can enjoy high definition entertainment from world-class, award-winning channels.

- ▶ To enjoy HDTV, you need to be using a HD-ready TV set that meets the following minimum specifications:



- Supports vertical video resolution of at least 720 lines
- Supports 16:9 Widescreen aspect ratio
- Supports the following Video Input types: High Definition Multimedia Interface (HDMI)
- Supports HDCP copy protection.

VIDEO RESOLUTION



HD programmes are broadcasted on a high visual quality with a vertical resolution of up to 1,080 lines.

In order to obtain the best viewing experience possible, adjust the video output of the IPTV set-top box using the remote control given.

The following four video output resolutions are available on the HD Interactive set-top box:
576i, 576p, 720p & 1080i (default).

To obtain the best visual experience, set the video output resolution to 1080i.

How To Use

Functions	Directions
❶ To view the current video resolution of the set-top box.	Press the HEX button  on your remote control. The current video output resolution will be shown on screen.
❷ To change Video output resolutions to 1080i.	Press the HEX button  on your remote control again. When you have reached the video output resolution of 1080i, release the HEX button  .



▶ Please note that on some HD-ready TV sets, you may experience problems displaying video output on the **576i** resolution. If you see a black screen on TV, please continue to press the **HEX** button  on your remote control to change to the next higher video output resolution.

SURROUND SOUND



Where available, HD programmes are broadcast with **Dolby® Digital 5.1 Surround Sound** effects.

If you are using a **Dolby® Digital 5.1** home theatre system, you can connect the IPTV set-top box to your home theatre system to complete your HDTV viewing experience with surround sound digital audio effects.

In the set-top box General Settings screen, enable **Dolby® Digital** audio output selection.



How To Use

Functions	Directions
<p>❶ To enable Dolby® Digital 5.1 audio output.</p>	<p>Press the MENU button  on your remote control.</p> <p>Use the navigation arrow buttons to select Settings followed by General Settings and Dolby Digital.</p> <p>Use the LEFT < or RIGHT > arrow button to change the selection to YES.</p> <p>Press the EXIT  or BACK  button to save your selection.</p>



▶ Enable Dolby® Digital audio output selection **ONLY** if you are using a Dolby® Digital 5.1 home theatre system or if your HD-ready TV supports Dolby® Digital surround sound.

Guide to IPTV Features

MAIN MENU AND OPTIONS

The Main Menu gives you complete access to all the IPTV features using a simple and intuitive design.

To access the Main Menu, press the **MENU** button  on your remote control and navigate using the navigation arrow buttons. The sub-menu will be displayed at the bottom of the screen (if applicable).

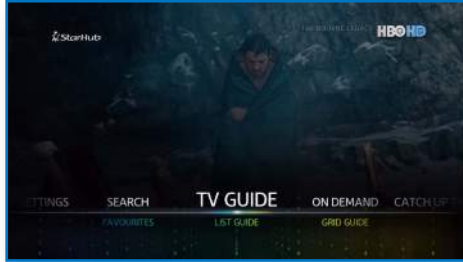

In different applications, the **MENU** button  also functions as an Options button. This is applicable to applications with the on-screen **MENU for options** prompt.

Similarly, Options can be navigated using the navigation arrow buttons and the **OK** button  for confirmation of selection.



INFO BAR









Info Bar gives you details of the programmes you are watching including the channel number, channel name, programme title, programme start and end times, short synopsis and cast. Details of programmes in the next 24 hours will also be available on the Info Bar.



▶ Information may not be available for some programmes.



How To Use

Functions	Directions
<p>1 To access the Info Bar for a programme you have selected.</p>	Press the INFO button  on the remote control.
<p>2 To access channel information for a programme currently showing on another channel.</p>	Use the UP  or DOWN  arrow button on your remote control to scroll through the channel listings.
<p>3 To check the programmes within 24 hours.</p>	Press RIGHT  arrow button to proceed to the next programme. Press LEFT  arrow button to go back to the previous programme.
<p>4 To access additional programme information (Info Page).</p> <p> ▶ For more information, refer to the Info Page on page 10.</p>	Press the INFO button  .
<p>5 To select your preferred audio track for the programme.</p> <p> ▶ Selection is possible only if another language is available.</p>	Press the AUDIO button  .



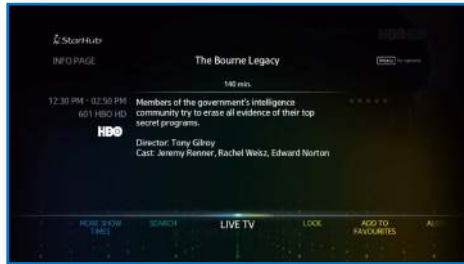

INFO PAGE

The Info Page offers you detailed information on a programme such as programme genre, programme duration, episode number and title, directors and cast and available audio tracks.

To access the Info Page from the Info Bar, press the **INFO** button .



How To Use

Functions	Directions
1 For More Show Times (if available).	Select More Show Times using LEFT < or RIGHT > arrow buttons. Press the OK button  to view more show times.
2 To Search for other programmes.	Select Search using the LEFT < or RIGHT > arrow buttons. Press the OK button  to confirm.
3 To Lock this channel	Select Lock using the LEFT < or RIGHT > arrow buttons. Press the OK button  to confirm.
4 To Add to Favourites	Select Add to Favourites using the LEFT < or RIGHT > arrow buttons. Press the OK button  to confirm.
5 For Programme Alert of selected programme. (for future events)	Select Alert using the LEFT < or RIGHT > arrow buttons. Press the OK button  to confirm. The Programme Alert will remind you 5 minutes before the start of the programme.

















ON-SCREEN TV GUIDE

The On-Screen TV Guide gives you access to comprehensive information on current and upcoming programmes including schedules, synopses, cast and crew, available audio tracks and programme genre for the channel of your choice. (Note: Information may not be available for some programmes).

To access the On-Screen TV Guide, press the **GUIDE** button  on your remote control. You will see the Channel Listing on your TV screen as shown below.



How To Use

Functions	Directions
1 To toggle between List Guide and Grid Guide.	Press the GUIDE button  on your remote control to toggle between List Guide and Grid Guide.
2 To choose a channel.	The channel you are currently watching is highlighted. Use the UP  or DOWN  arrow button on your remote control to scroll through the list of channels and press the OK button  to go to the channel you wish to watch.
3 To access current and upcoming programmes list.	Press the RIGHT  arrow button on your remote control for Programme Listing (for Grid) or DOWN  arrow button (for List).
4 To access programme schedules for today.	On the Programme Listing Page, press the LEFT  or RIGHT  arrow buttons (for Grid) and UP  or DOWN  arrow button (for List) to scroll.
5 To access programme schedules for tomorrow.	Press the NEXT  button on your remote control.
6 To access programme schedules from 4th to 7th day.	Press the NEXT  button on your remote control. Press the PREVIOUS  button to return to the previous day.
7 To go to the previous or next page.	Press the CH UP  or CH DOWN  to go to the previous or next page.
8 For additional information on programmes. <div style="border: 1px solid #ccc; background-color: #f0f0f0; padding: 5px; margin-top: 10px;">  Additional programme information such as synopses, cast and audio tracks may not be available for some programmes. </div>	Press the INFO button  .
9 To set default Listing or Grid Guide.	Press MENU . Select Settings followed by General Settings and Guide Style : select List or Grid .

GENRE SEARCH

To help you find your favourite programmes easily, you can sort the channels in the On-Screen TV Guide according to their genre.



By default, the channels are arranged according to Channel Number.

You can sort the channels in the On-Screen TV Guide based on one of the following:

- Alphabetical
- Favourites
- My Subscribed Channels
- International
- Ethnic
- Sports
- Kids
- Education
- Lifestyle
- Entertainment
- Movies
- News
- Chinese



How To Use



Functions	Directions
<p>1 To sort the channels in the On-Screen TV Guide according to genre.</p>	<p>Press the GUIDE button  on your remote control.</p> <p>The channels are arranged according to Channel Number by default. Press the MENU button  for Options and select Sort. Press the OK button  to arrange the channels according to your selection.</p>

MORE SHOW TIMES

More Show Times offers you the ease of checking the alternative show times of your favourite programme.



How To Use





Functions	Directions
<p>1 To access more show times function.</p>	<p>Press the GUIDE button  on your remote control.</p> <p>Press the RIGHT > arrow button to select a programme (for List Guide).</p> <p>Press the MENU button  for Options and select More Show Times to list the alternative show times of the selected title.</p> <p>OR</p> <p>Press the INFO button  for the info Page and select More Show Times to list the alternative show times of the selected title.</p>

PROGRAMME INFORMATION IN CHINESE

This mode allows for programme information to be in Chinese text for Chinese channels and in English text for all other channels. If you prefer, you may change the Preferred Language Setting to English to view all programme information in English only.



How To Use







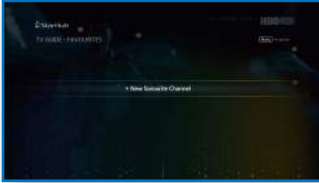



Functions	Directions
<p>1 To change the Preferred Language.</p>	<p>Press the MENU button , select Settings followed by General Settings then Preferred Language using the arrow buttons.</p> <p>Use the LEFT < or RIGHT > arrow button to select Bilingual or English as the Preferred Language Setting.</p> <p>Press the EXIT  or BACK  button to save your selection.</p> <div style="background-color: #e6f2ff; padding: 5px;"> <p> ▶ Chinese programme information is available only for Chinese programmes.</p> </div>

FAVOURITE CHANNELS

You can switch within a pre-selected list of preferred channels by pressing the **FAVOURITE** button  on your remote control. To begin, you must select the channels to be included in your list of favourite channels.





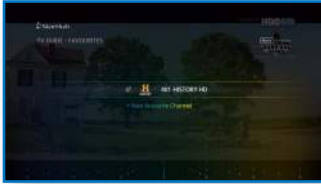

How To Use

Functions	Directions
<p>1 To set a favourite channel.</p>	<p>Press the MENU button  on your remote control.</p> <p>Select TV Guide followed by Favourites on the TV screen using the arrow buttons. Press the OK to launch Favourites.</p> <p>Press the OK button  on + New Favourite Channel. Select your channel category and press the RIGHT > arrow button to choose the channels in the selected category.</p> <p>Press the UP ^ or DOWN v arrow button to choose the channels and the OK button  to add the channel to your Favourites list.</p> <p>Press the BACK  button to return to the Favourites list.</p>
<p>2 To access a favourite channel.</p> <p>► The FAVOURITE button will only tune to the channels in the activated Favourites List.</p>	<p>Option 1 Press the FAVOURITE button  on your remote control to access your favourite channels. Surf your favourite channels by pressing the FAVOURITE button .</p> <p>Option 2 Press the GUIDE button  while watching TV. Press the MENU button  and select Sort. Select Favourites and press the OK button . Your favourite channels will be listed. Select the channel you want to watch and press the OK button .</p>

FAVOURITE CHANNELS



How To Use

Functions	Directions
<p>3 To remove a favourite channel.</p>	<p>Press the MENU button  on your remote control.</p> <hr/> <p>Select TV Guide followed by Favourites on the TV screen using the arrow buttons. Press the OK button  to launch Favourites.</p> <hr/> <p>Press the OK button  to select the favourite channel(s) and press the MENU button  for options to choose an action: Delete this channel / Delete selected channels / Delete all channels.</p>

LAST CHANNEL RECALL









For instant access to the channel you were last viewing, press the **LIVE TV** button  on the viewing channel.

SEARCH

The Search feature allows you to look for your favourite programmes within TV Guide, Video On Demand, Catch Up TV and/or On Demand Channels. You can search based on the programme title.



How To Use







Functions	Directions
<p>1 To access search function.</p>	<p>Press the MENU button  on your remote control and select SEARCH.</p> <p>Use the navigation arrow buttons to highlight the letter and press the OK button  to input into the search.</p> <p>To correct a mistake, select the “◀” or “▶” to select the position and select DELETE “.</p> <p>After the entry of the key words, navigate to DONE and press the OK button  to browse the search result. Use the UP  or DOWN  arrow button and the OK button  to view the details.</p> <p>Press the NEXT  or PREVIOUS  button to change the search filter.</p>

GENERAL SETTINGS

This function personalises your viewing preferences.



How To Use

Functions	Directions
<p>❶ To change Display Date / Time.</p>	<p>Press the MENU button  on your remote control. Select Settings followed by General Setting, then select Display Date/Time using the arrow buttons.</p> <p>Use the LEFT < or RIGHT > arrow button to set whether you wish the Date and Time to appear on the TV screen.</p> <p>Press the EXIT  or BACK  button to save your selection.</p>
<p>❷ To change Info Bar Duration.</p>	<p>Press the MENU button  on your remote control. Select Settings followed by General Setting, then select Info Bar Duration using the arrow buttons.</p> <p>Use the LEFT < or RIGHT > arrow button to set the duration you wish the Info Bar to appear on the TV screen.</p> <p>Press the EXIT  or BACK  button to save your selection.</p>
<p>❸ To change Preferred Language.</p>	<p>Select Settings followed by General Setting and Preferred Language. Use the LEFT < or RIGHT > arrow button to change the settings.</p> <p>The default language is Bilingual. This mode allows for programme information to be in Chinese text for Chinese channels and English text for all other channels.</p>
<p>❹ To change Preferred Audio.</p>	<p>Select Settings followed by General Settings and Preferred Audio. Use the LEFT < or RIGHT > arrow button to select your preferred Audio language.</p>

GENERAL SETTINGS



How To Use

Functions	Directions
<p>5 To change Preferred Subtitles.</p>	<p>Select Settings followed by General Settings and Preferred Subtitles. Use the LEFT < or RIGHT > arrow button to select your preferred subtitle language.</p>
<p>6 To change Time Format.</p>	<p>Select Settings followed by General Settings and Time Format. Use the LEFT < or RIGHT > arrow button to select your preferred Time Format.</p>
<p>7 To change Auto Load Ch Apps.</p>	<p>Select Settings followed by General Settings and Auto Load Ch Apps. Use the LEFT < or RIGHT > arrow button to set whether you wish to load channel applications automatically (like On Demand Channels, KaraOK! or Interactive TV)</p>
<p>8 To change resolution.</p>	<p>Select Settings followed by General Settings and Resolution:</p> <ul style="list-style-type: none"> • 576i • 576p • 720p • 1080i
<p>9 To change Background.</p>	<p>Select Settings followed by General Settings and Background. Use the LEFT < or RIGHT > arrow button to select your preferred background style for the user interface.</p>



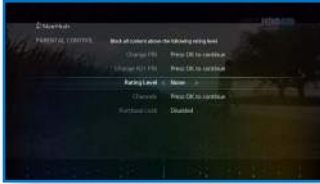









PARENTAL CONTROL

This feature allows parents to control what their children can watch.











To access Parental Control, press the **MENU** button  on your remote control, navigate to Settings. Select Parental Control and press the **OK** button . You will be prompted to enter the 6-digit Parental PIN (the default is 000000).

How To Use

Functions	Directions
<p>1 To set Rating Level</p>	<p>All content above the selected rating level will be blocked. Note that this feature is subjected to the availability of the advisory rating in the programme information.</p> <hr/> <p>Use the LEFT  or RIGHT  arrow button to select the available rating levels:</p> <ul style="list-style-type: none"> • None • G • PG • PG13 • NC16 • M18 <hr/> <p>Press the EXIT  or BACK  button to save your changes.</p>
<p>2 To lock a channel.</p>	<p>All channels in the list will be locked at all times and can be unlocked using the Parental PIN when you tune to the channel.</p> <hr/> <p>Select Channels and press the OK button .</p> <hr/> <p>Press the OK button  on + New. Select your channel category and press the RIGHT  arrow button to choose the channels in the selected category.</p> <hr/> <p>Press the UP  or DOWN  arrow button to choose the channels and the OK button  to select the channel. Press the MENU button  for Options to lock the selected channel(s).</p> <hr/> <p>Press the BACK  button to return to the Locked Channel List.</p>

PARENTAL CONTROL

How To Use

Functions	Directions
<p>3 To unlock a channel</p>	<p>Select Channels and press the OK button .</p> <p>To unlock an individual channel: Select the channel in the list and press the OK button  to unlock.</p> <p>To unlock all the channels: Select Unlock All and press the OK button .</p>
<p>4 To set Purchase Lock</p>	<p>This feature prevents children from making unauthorised purchases on the Set-top Box. Once the Purchase Lock is enabled, the Parental PIN will be requested everytime before the purchase can be completed.</p> <p>Use the LEFT < or RIGHT > arrow button to Enable/Disable this feature.</p> <p>Press the EXIT  or BACK  button to save your changes.</p>
<p>5 To change Parental PIN</p> <p> Please be reminded that the PIN should be kept confidential.</p>	<p>This feature allows you to replace the default or old PIN of your HD interactive Set-top Box with a new one. The PIN should be kept confidential as it will enable you secured access to selected services or features.</p> <p>Select Change PIN and press the OK button . You will be prompted to enter your new PIN, enter your new 6-digit numeric PIN.</p> <p>On the next screen, enter and confirm your new PIN. Enter again your new 6-digit numeric PIN.</p> <p>A message will appear on-screen to inform you if the change has been successful. Press the OK button  again to return to the Parental Control Menu.</p>
<p>6 To change R21 PIN</p>	<p>The steps to change your R21 PIN are similar to the Change Parental PIN above.</p> <p>Note that this feature is only applicable to customers who registered for the R21 PIN at StarHub shops or customer service centres.</p>

Guide to Video On Demand

CATALOGUE PAGE

StarHub Video On Demand (VOD) services offer you a wide selection of content which you can watch instantly at your convenience.

[Video On Demand Services](#)

Save the hassle of running to the video rental store - Now, you can shop for the video-on-demand titles you want and watch them instantly. Select from a wide variety of content, ranging from movies, sports special to ethnic shows and Asian drama series. For drama series, you can buy a single episode or the entire series and enjoy them in the language you like (for series that come in dual sound).







To access Video On Demand services, press the **VOD** button  on your remote control. You can choose among Movies, Shows, KaraOK! and On Demand Channels.

For access to On Demand Channels, please check your subscription packages for entitlements.





How To Use

Functions	Directions
<p>❶ To access Movies or Shows On Demand</p>	<p>Press the VOD button  on your remote control. Select Movies or Shows and press the OK button .</p>
<p>❷ To browse the titles from the different categories</p>	<p>Use the LEFT < or RIGHT > arrow buttons to browse the different categories. Each category will provide a snapshot of the titles available.</p> <p>Press the OK button  on the selected category. Use the LEFT < or RIGHT > arrow buttons to browse the different titles.</p> <p>Press the OK button  to view the Info Page with the various purchase options.</p>
<p>❸ To use the Search function</p>	<p>Press the MENU button  for Options and select the Search option. Press the OK button  to use the search function.</p>

INFO PAGE

The Info Page provides information on the programme you have selected such as programme title, the duration of the programme, the episode number when applicable and the programme synopsis.

At the same time, you can also find the various purchase options available for the selected programme. Information such as the expiry date of the viewing period and pricing details will also be shown on this page.



To access the **Info Page**, select the titles and press the **OK** button .



▶ If titles are free or have been purchased before, title will play immediately.









How To Use

Functions	Directions
<p>1 To purchase a title/individual episode/series</p>	<p>For Movies: Press the OK button  and follow the on-screen instructions to complete your purchase.</p>
	<p>For Shows: Press the OK button  and select your purchase option for an individual episode or the entire series. Follow the on-screen instructions to complete your purchase.</p>
	<p>The programme will play immediately once the transaction is successful.</p>

MY PURCHASED CONTENT

In My Purchased Content, you can view the list of the titles/series that you have recently purchased. You can access My Purchased Content from both Movies and Shows On Demand.

How To Use













Functions	Directions
<p>1 To play a purchased title/series.</p>	<p>Press the VOD button  on your remote control to launch Video On Demand.</p>
	<p>Select Movies or Shows and press the OK button .</p>
	<p>Press the MENU button  for Options and select My Purchased Content. Press the OK button .</p>
	<p>In My Purchased Content, use the LEFT < or RIGHT > arrow buttons to select the title or series. Press the OK button  to view the Info Page.</p>
	<p>In the Info Page, press the OK button  to start watching.</p>

KARAOKE! - SONG CATALOGUE

KaraOK! offers a wide selection of Chinese, English, Dialect, Evergreen and Malay songs. You can now sing and practise your favourite or latest songs in the comfort of your home.



How To Use





Functions	Directions
<p>1 To access and subscribe KaraOK!</p>	<p>Press Ch 888 on your remote control. OR Press the MENU button , select On Demand followed by KaraOK! using the arrow and OK buttons.</p> <p>If you have not subscribed to KaraOK!, use the UP  or DOWN  arrow buttons to select the package and press the OK button  to purchase.</p> <p>For customers who have subscribed to KaraOK!, the catalogue will appear upon tuning in to Ch 888.</p>
<p>2 To browse and select songs from the catalogue.</p>	<p>Use the navigation arrow buttons to scroll through the categories, and press the OK button  to confirm.</p> <p>Alternatively, you can press the corresponding number key to go to the respective categories.</p>
<p>3 To schedule a song.</p>	<p>At the listings of songs, select the song you wish to schedule and press the OK button  or the corresponding number.</p> <p>The song title will be highlighted when it has been scheduled in the playlist.</p>
<p>4 To change the text between English and Chinese.</p>	<p>Press the MENU button , for Options and select Bilingual/English.</p>
<p>5 To go to the previous or next page.</p>	<p>Press the CH UP  or CH DOWN  to go to the previous or next page.</p>
<p>6 To hide the song catalogue.</p>	<p>Press the EXIT button  or OK button  to launch the main page.</p>
<p>7 To launch the song catalogue from the video screen.</p>	<p>Press the MENU button  to launch the main page.</p>

KARAOKE! - PLAYLIST

KaraOK! offers a similar experience as the commercial Karaoke outlets, where you can schedule your favourite songs to be played out in a sequence. The order of the songs can be changed and managed from the Playlist.



How To Use

Functions	Directions
1 To launch the Playlist.	Press the MENU button  for Options and select Current Playlist .
2 To insert a song.	Select the song and use the LEFT < or RIGHT > arrow buttons to toggle the mode to Insert and press the OK button  . The song will be rescheduled as the next song to be played out.
3 To repeat a song.	Select the song and use the LEFT < or RIGHT > arrow buttons to toggle the mode to Repeat and press the OK button  . The song entry will be duplicated in the playlist and will be repeated.
4 To delete a song.	Select the song and use the LEFT < or RIGHT > arrow buttons to toggle the mode to Remove and press the OK button  .

KARAOKE! - FAVOURITES

KaraOK! allows you to add your favourite songs to a favourites list, so that you can have quick access without having to create your playlist from scratch the next time you return.



- ▶ Your favourites list will be accessible according to your subscription period (day pass or monthly subscription). Once your subscription expires, your favourites list will be automatically deleted from the set-top box.

















How To Use

Functions	Directions
❶ To launch Favourites.	Press the MENU button for Options and select Favourites .
❷ To add a song to Favourites.	Select the song and press the MENU button for Options and select Add to Favourites .
❸ To load Favourites as playlist.	Press the MENU button for Options and select Load Favourites . The current playlist will be replaced with the Favourites list.
❹ Add a favourite song to playlist.	Select the song in Favourites and use the LEFT < or RIGHT > arrow buttons to toggle to Add and press the OK button . The song will be added to the current playlist.
❺ Delete a favourite song.	Select the song in Favourites and use the LEFT < or RIGHT > arrow buttons to toggle to Remove and press the OK button . The song will be deleted from Favourites.

KARAOKE! - OTHER FEATURES

There are many other functions that will complement your home karaoke singing experience such as the search feature. You can also forward or rewind the songs and practise a new song over and over again from the comfort of your home.

How To Use

Functions	Directions
1 To change the audio mode.	Press the AUDIO button  to switch between Karaoke or Audio mode.
2 To view the current and next song on the full video screen.	At the full video screen, press the INFO button  to view the current and next song. To hide, press the EXIT button  .
3 Rewind or fast forward the song.	Press the REWIND  or FORWARD  button on your remote control to increase the speed by 2x. You can press the REWIND  or FORWARD  button again to increase the speed.
4 To restart the song.	Press the PREVIOUS  button on your remote control.
5 To go to the next song.	Press the NEXT  or STOP  button on your remote control.
6 To pause the song.	Press the PAUSE button  on your remote control. To resume the song, press the PLAY button  .
7 To search of songs or artiste.	Select one of the Search feature from the main catalogue: - Search By Artistes (Keyword) - Search By Artistes (Pinyin) - Search By Songs (Keyword) - Search By Songs (Pinyin) Use navigation arrow buttons and press the OK button  to select the alphabets. For keyword searches, key in a key word e.g. "World" and all related songs with the word "World" will appear. For Pinyin, key in "ZXY", if you want to search for "Zhang Xue You". After the completing the entry, select DONE to start the search. Select the song and press the OK button  to schedule and play the song.

Guide To Interactive Services

INSTANT BUY

Instant Buy allows you to subscribe to selected channels and packages instantly, using your remote control. You can start to enjoy your subscribed channels immediately upon successful transaction.



How To Use

Functions	Directions
<p>1 To subscribe to channel.</p>	<p>Tune to the channel you wish to subscribe.</p> <p>Press the BLUE button to subscribe to this channel.</p> <p>Select SUBSCRIBE and press the OK button to confirm. Pricing and subscription information will be displayed.</p> <p>Press the BLUE button to continue.</p> <p>Select YES and press the OK button to process your request. Upon successful transaction, the channel will be activated and you can start viewing it instantly.</p>
<p>2 To preview a short video about the channel (if available).</p>	<p>Tune to the channel you wish to preview.</p> <p>Press the BLUE button to preview a short video.</p> <p>If a preview video is available, select PREVIEW and press the OK button to confirm. The video will start to play out instantly.</p>
<p>3 To return to other channels from the application.</p>	<p>Press the EXIT button .</p> <p>Select YES and press the OK button to confirm.</p> <p>Press the CH UP or DOWN arrow button to tune to other channels.</p>









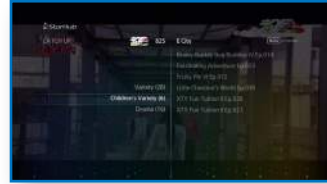

- ▶ Video Signal will appear almost instantaneously when the transaction is successful.
- ▶ Additional set-top boxes in the account will be activated with the channel within a short interval.
- ▶ When the network is busy, the video signal may not be activated immediately. A message will be displayed. You may exit and return later to view the channel.

CATCH UP TV (AVAILABLE ONLY FOR SELECTED CHANNELS)

Catch Up TV allows you to catch up episodes of TV shows you missed, anytime within 7 days of the first telecast.



How To Use

Functions	Directions
1 To access the list of Catch Up TV channels.	Press the MENU button  and select Catch Up TV.
2 To access Catch Up TV from a channel.	Tune to a channel with Catch Up TV and press the YELLOW button  when the icon appears at the top right corner of the screen.
3 To select the categories within Catch Up TV.	Use the UP  or DOWN  arrow buttons to select a category and press OK button  or RIGHT  arrow button to browse the programmes in that category.
4 To play a programme.	Use the UP  or DOWN  arrow buttons to select a programme and press OK to view the show information. Press th OK button  on Watch to play the programme.

START OVER AND ETV

You can now enjoy the ability to restart and watch it from the start. Keep a look out for the on screen prompt for programmes that come with this feature, and press the BLUE button on your remote control to start watching from the beginning.





Shows airing on Start Over channels can be restarted multiple times within their normal broadcast time. For example, your favourite Hong Kong TVB series is on VV Drama from 9pm to 10pm, you will be able to Start Over that programme anytime between 9pm and 10pm.



eTV provides you more interactivity with your favourite TV programme. You can get more information on the programme you are watching while watching TV.

To access eTV, press the **GREEN** button  on the remote control when the eTV icon appears on the top of the screen.

How To Use

Functions	Directions
1 To access the different tabs on eTV.	Use the navigation arrow buttons to select the different tabs. Select OK button  to confirm.
2 To select the categories within eTV.	Use the navigation arrow buttons to select the different tabs. Select OK button  to confirm.
3 To exit eTV and return to the last watched channel.	Press the BACK  , EXIT  or LIVE TV  buttons.

INTERACTIVE TV

Interactive TV on channel 899 brings you a whole new level of experience via your existing TV, into a world of information and interactivity, 24 hours a day, 7 days a week.

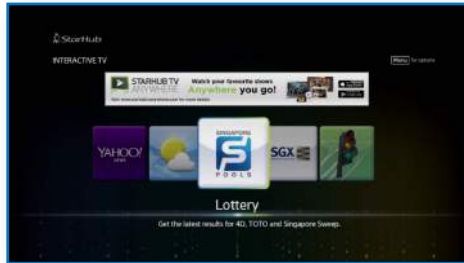

The suite of content available for a start includes, “Live” Financial Stock prices, Lottery results, Weather forecast, Yahoo! News and Traffic Information.



- The information displayed is from third party sources and is provided on an “as is” and “as available” basis. StarHub Cable Vision Ltd and its affiliates make no representation or warranty as to the accuracy, timeliness, correctness or completeness of any information displayed and expressly disclaim all representations or warranties of any kind including implied warranties of merchantability, satisfactory quality, fitness for a particular purpose and non-infringement.

Technical Information

INSTALLATION GUIDE

Recommended Set-Up: Connection via HDMI (High Definition Multimedia Interface)

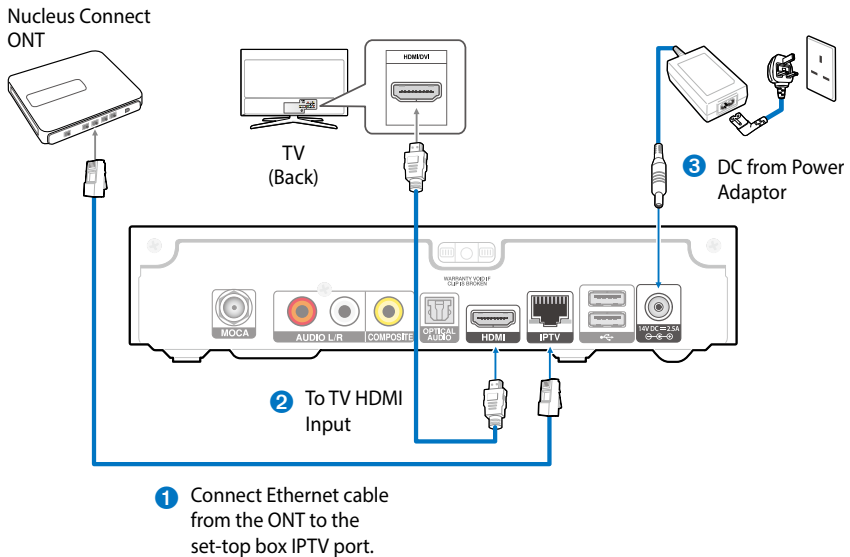

- ▶ For this connection, your HD-ready TV must support input for **HDMI**.
- ▶ If your HD-ready TV does **not** support **Dolby® Digital 5.1** surround sound, select No under the Dolby® Digital audio selection at the Preferences Setting screen.
- ▶ Some HD-ready TV models **may** have compatibility problems with the IPTV set-top box when connected using the **HDMI** connection. If your TV set is "**HD-ready**" TV but still experience problems displaying video, please connect the set-top box to your HD-ready TV using the **Optional set-up**.

Viewing Procedure

1. Switch your TV source to **HDMI** to watch your programmes.
2. Select the desired channel using the remote control of your IPTV set-top box.

Optional Set-Up: Connection via Composite Video & Audio

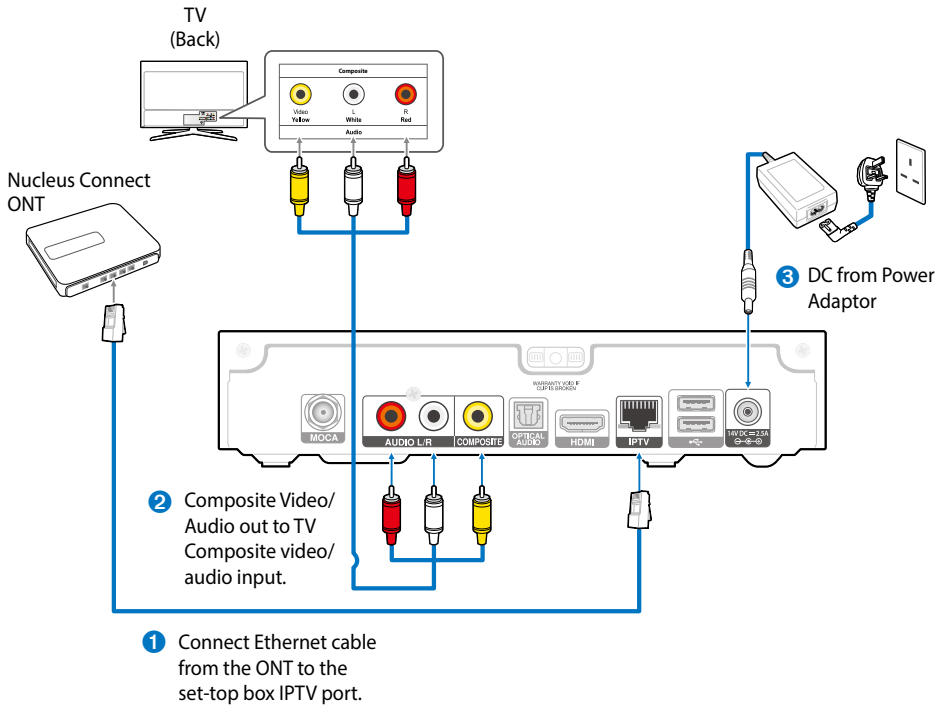

- ▶ For this connection, your HD-ready TV must support input connections for Composite Video and Composite Audio (L-R).

Viewing Procedure

- 3.** Switch your TV source to Composite (or AV) to watch your programmes.
- 4.** Select the desired channel using the remote control of your IPTV set-top box.



- ▶ On some HD-ready TV models, you may experience a problem displaying video output on 576i resolution. If you see black screen on TV, please continue to press the **HEX** button  on your remote control to change the output resolution to the next higher value.

Troubleshooting

TIPS FOR IMPROVING TV RECEPTION

If you experience any disturbance in your TV reception, the problem may be due to a minor oversight. Here's an important checklist that may help you locate the source of the problem quickly:

- Always ensure that all devices (TV, set-top box) are plugged into your power outlet and the power is turned on.
- Ensure that all physical connections are secured and connected correctly.
- Ensure that the Ethernet Cable is not bent and there are no heavy objects resting on it.

In addition, you can also try the following steps:

Picture leaning/flipping

- Adjust horizontal control of TV unit.

Picture too bright or dark

- Adjust brightness control of TV unit.

Blank screen, sound ok

- Check if TV brightness and contrast controls are adjusted.

Picture rolling

- Adjust vertical hold of TV unit.

No sound, picture ok

- Adjust TV or set-top box volume control.
- Check if either are in MUTE mode.

Washed-out picture

- Adjust TV contrast control.

No picture

- Turn OFF and turn ON the main power to the set-top box.
- Check all connections.
- Check other channels.

Pixelised picture

- Check other electrical appliances in operation.
- Check for loose connection.
- Check other channels.

Remote control not working

- Check for obstacles in the line of sight between the remote control and the set-top box.
- Check the batteries of the remote control for the set-top box.

If you encounter any difficulties which you cannot resolve, we will be pleased to be of assistance. For customer care enquiry, please call 1633 or visit community.starhub.com.

General Information

[Rovi Product Notice](#)

This item incorporates copy protection technology that is protected by U.S. patents and other intellectual property rights of Rovi Corporation. Reverse engineering and disassembly are prohibited.

[Dolby Digital Product Notice](#)

Manufactured under license from Dolby Laboratories. "Dolby" and the double-D symbol are trademarks of Dolby Laboratories.



[HDMI Product Notice](#)

The terms HDMI and HDMI High-Definition Multimedia Interface, and the HDMI Logo are trademarks or registered trademarks of HDMI Licensing LLC in the United States and other countries.



OPEN SOURCE SOFTWARE LICENSE NOTICE

You may find a copy of the open source software and more information at <http://opensource.samsung.com>

Memo

Memo

Memo



67 Ubi Avenue 1
StarHub Green
Singapore 408942